

V4 MR16 Dimmable



ALTLED® Asteria Series

Specification Sheet

ALT Transformer ONLY

Product Introduction

ASTERIA is a minor planet that orbits the Sun, and also considered in the Greek Mythology as the Amazon that defeat the all mighty Heracles. ALT's ASTERIA can be presented as a strong, smart and efficient light bulb. ALT's Asteria MR16 series guarantees the outstanding efficiency and quality of High Power Products. All these make our MR16 products ideal for general business and decorative lighting purpose, including shop Lighting, Hotel lighting, and Commercial Applications. You can simply install it within the showcase of the boutique, and add up bonus for the display. Also, Asteria series MR16 Dimmable can easily and smartly help you lessen energy consumption up to 90%, it will enhance your business profitability and help the environment to flourish. Asteria MR16 series certainly be the product to create a more beautiful and efficient world.

Certificates



Features

- ✓ Smooth dimming function fades from 100% to 0% light output without flicker.
- ✓ Elegant, rich and long-lasting lighting output ideal for Interior design.
- ✓ High density aluminum increase heat dissipation.
- ✓ Up to 90% energy saving compared to standard halogen lamp.

Application

- ✓ Shop Lighting
- ✓ Commercial Lighting
- ✓ Boutique Lighting
- ✓ Illumination Lighting
- ✓ Hotel Lighting

Specifications

Chipset Luminous Flux



Item	Specification	Details		
Output	Beam Angle	15°, 25°, 38°, 45°, 72°, 120°		
	Colour Range	TW / NW / WW / R / G / B		
	Lumen Maintenance	30,000+ hours		
Electrical	Input Voltage	110V AC or 220V AC		
	Power Consumption	7 Watts		
Physical	Bases	<ul style="list-style-type: none"> · GX 5.3 / GU 5.3 · E26 / 24 (US) · E26 / 27 (EURO) · GU10 / GZ10 · EZ10 · E11 · E12 · E14 · E17 · B22D · BA15D · BA15S 		
		Weight	0.88 ~ 1.69 oz. (25 ~ 48 g)	
		Lens	Optics PMMA	
		Operating Temperature	-4° F to 104° F (-20°C to 40°C)	
		Humidity	0 – 95%, non-condensing	
		Certification and Safety	Certifications	CE , FCC , C-tick , RoHS, LVD , Laser Testing, ETL, REACH
			Environment	Not for use in totally enclosed fixtures Suitable for damp location
			Warranty	3 years
		Two Million Worldwide Product Liability Insurance.		

Chipsets	LUXEON Rebel		CREE XP-C
Power Consumption	7 W	7 W	7 W
LED Qty	4 pcs	2 pcs	4 pcs
CRI	80		
Beam Angle 10%	25° / 45°	38° / 72°	25°/120°
True White ○	520 lm	400 lm	520 lm
Natural White ○	520 lm	400 lm	455 lm
Warm White ●	400 lm CRI 90 320 lm	250 lm CRI 90 200 lm	420 lm
Red ●	210 lm	190 lm	-
Green ●	520 lm	400 lm	-
Blue ●	160 lm	130 lm	-

Chipsets	LUXEON Rebel	
Power Consumption	7 W	
LED Qty	4 pcs	
CRI	80	
Beam Angle 50%	15°	
True White ○	520 lm	
Natural White ○	520 lm	
Warm White ●	400 lm CRI 90 320 lm	
Red ●	210 lm	
Green ●	520 lm	
Blue ●	160 lm	

Chipsets	EPISTAR	
Power Consumption	7W	
CRI	98	
Beam Angle 10%	100° / 135°	
True White ○	330 lm	
Warm White ●	240 lm	

※All Chipset Luminous Flux Data are indicated in max values.

Optical Characteristics

Dominant Wavelength (nm) or Colour Temperature (K)

Correlated Colour Temperature	Min.	Typ.	Max.
True White	4500K	6500K	10000K
Natural White	3500K	4100K	4500K
Warm White	2540K	3100K	3500K
Red	620.5nm	627nm	645nm
Green	520nm	530nm	550nm
Blue	460nm	470nm	490nm

Illuminance at Distance

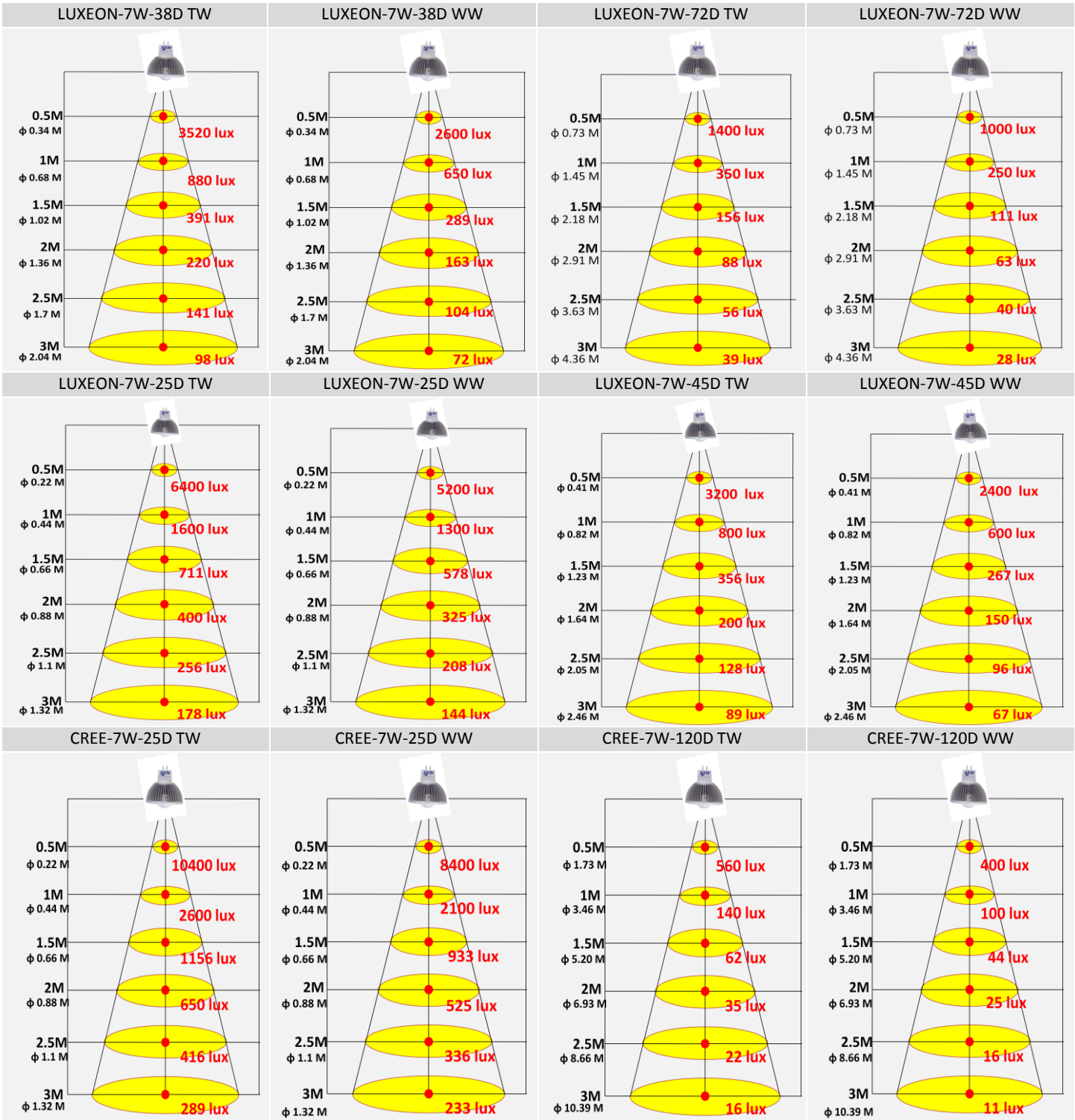

Mechanical Dimensions

Design GX5.3 / GU 5.3



Design E26/24 (US)



Design E26 / 27 (EURO)



Design GU10/GZ10



Design E11



Design E14 (US)



Design E14 (EURO)



Design E17



Design B22D



Design E12 (US)

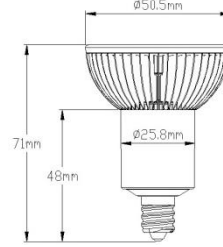

Design E12 (EURO)

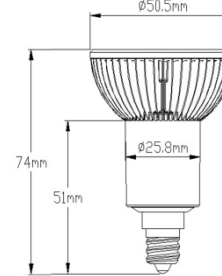

Design E210



Design BA15D

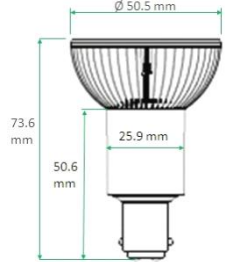

Design BA15S



M01 Fixture

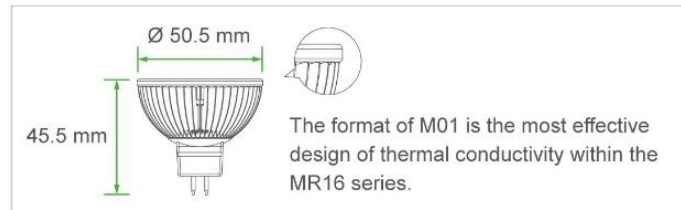

M02 Fixture



ALT 8V Transformer

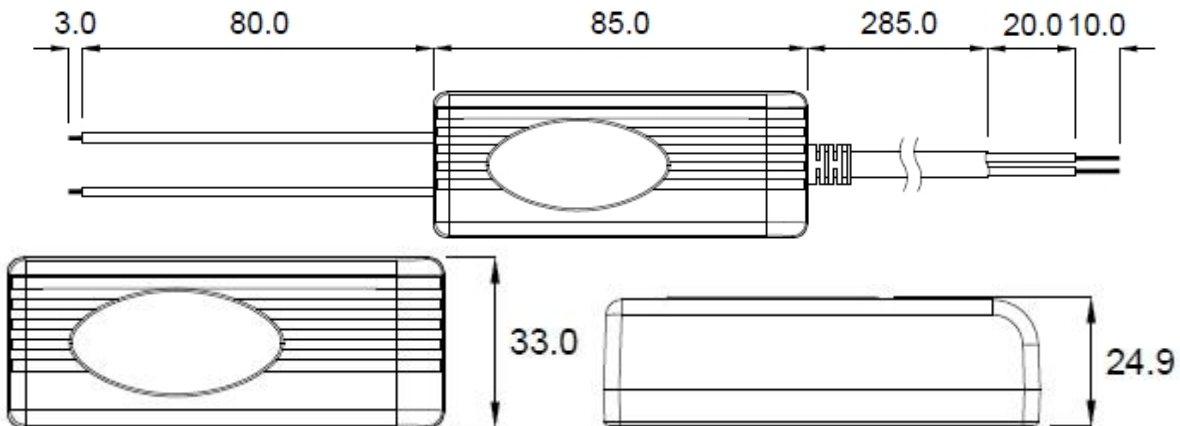

Unit : mm

Transformer Installation Instruction

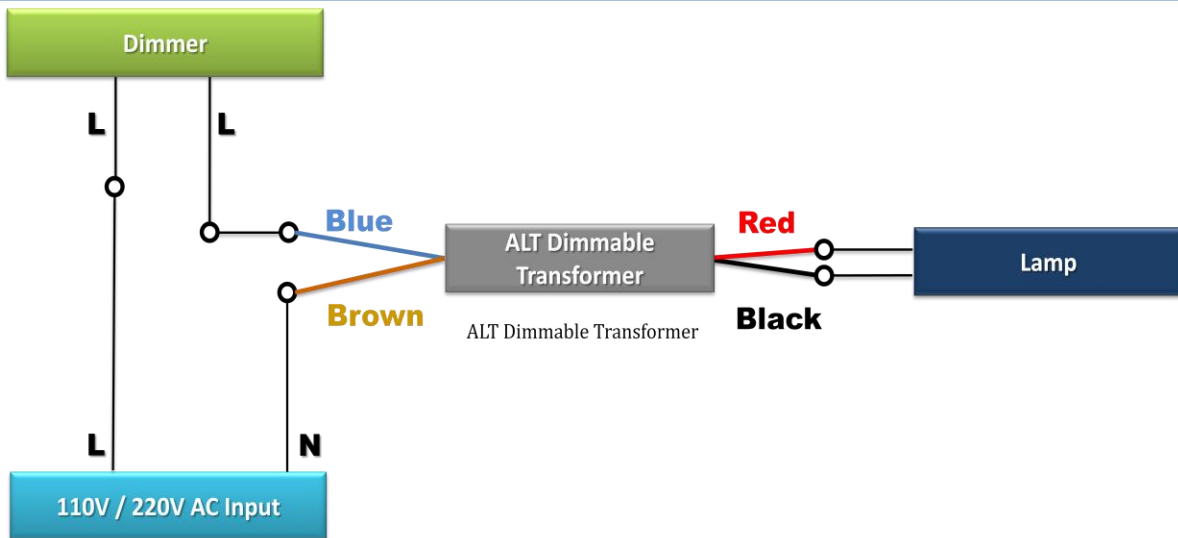

Compatible Dimmers List

Compatible Dimmers List		
100V~120V AC Types		
Brand	Type	Max. Watts
ELECTRON	CONTROL	500W
LUTRON	TGCL-153PH-LA	150W
LUTRON	TG-600P	600W
LUTRON	TG-603PR-WH	600W
LUTRON	CTEL-303P	600W
LUTRON	CTCL-153PDH-WH	600W
LUTRON	DVLV-600P	600W
LUTRON	MAELV-600	600W
LUTRON	DV-603PR-WH	600W
LUTRON	S-600P-WH	600W
LUTRON	S-600H-WH	600W
LEVITON	IPL06	600W
LEVITON	IPI06	600W
LEVITON	R60-6684-1IW	600W

Compatible Dimmers List		
220V~240V AC Types		
Brand	Type	Max. Watts
CLIPSAL	TRAILING EDGE 32E450TM	450W
CLIPSAL	UNIVERSAL EDGE 31E2RUDM	350W
HPM	TRAILING EDGE - Cat 400T	400W
Hagerblu	LEADING EDG WBMD401TO	400W