

V3 MR16 Dimmable



ALT Transformer ONLY

ALTLED® **Asteria** Series

Specification Sheet

Product Introduction

ASTERIA is a minor planet that orbits the Sun, and also considered in the Greek Mythology as the Amazon that defeat the all mighty Heracles. ALT's ASTERIA can be presented as a strong, smart and efficient light bulb. ALT's Asteria MR16 series guarantees the outstanding efficiency and quality of High Power Products. All these make our MR16 products ideal for general business and decorative lighting purpose, including shop Lighting, Hotel lighting, and Commercial Applications. You can simply install it within the showcase of the boutique, and add up bonus for the display. Also, Asteria series MR16 Dimmable can easily and smartly help you lessen energy consumption up to 90%, it will enhance your business profitability and help the environment to flourish. Asteria MR16 series certainly be the product to create a more beautiful and efficient world.

Certificates



Features

- ✓ Smooth dimming function fades from 100% to 0% light output without flicker.
- ✓ Elegant, rich and long-lasting lighting output ideal for Interior design.
- ✓ High density aluminum increase heat dissipation.
- ✓ Up to 90% energy saving compared to standard halogen lamp.

Application

- ✓ Shop Lighting
- ✓ Commercial Lighting
- ✓ Boutique Lighting
- ✓ Illumination Lighting
- ✓ Hotel Lighting

Specifications

Chipset Luminous Flux



Item	Specification	Details		
Output	Beam Angle	30°, 38°, 45°, 50°, 60°, 72°, 80°, 90°, 110°, 120°, 135°		
	Colour Range	TW / NW / WW		
	Lumen Maintenance	30,000+ hours		
Electrical	Input Voltage	110V AC or 220V AC		
	Power Consumption	7 Watts		
Physical	Bases	<ul style="list-style-type: none"> · GX 5.3 / GU 5.3 · E26 / 24 (US) · E26 / 27 (EURO) · GU10 / GZ10 · E210 · E11 · E12 · E14 · E17 · B22D · BA15D · BA15S 		
		Weight	0.88 ~ 1.69 oz. (25 ~ 48 g)	
		Lens	Optics PMMA	
		Operating Temperature	-4° F to 104° F (-20°C to 40°C)	
		Humidity	0 – 95%, non-condensing	
		Certification and Safety	Certifications	CE , FCC , C-Tick , RoHS , LVD , Laser Testing, ETL, REACH
			Environment	Not for use in totally enclosed fixtures Suitable for damp location
			Warranty	3 years
		Two Million Worldwide Product Liability Insurance.		

Chipsets	CREE XM-L	CREE MC-E
Power Consumption	7 W	
CRI	80	
Beam Angle	10% 30° / 45° / 72° / 90° / 110° / 120°	38° / 60° / 80° / 120°
True White	520 lm	475 lm
Natural White	450 lm	410 lm
Warm White	390 lm	355 lm

Chipsets	BRIDGELUX
Power Consumption	7 W
Beam Angle	10% 50° / 60° / 72° / 120°
True White	CRI 65 450 lm
Warm White	CRI 82 300 lm

Chipsets	BRIDGELUX SM4
Power Consumption	7 W
Beam Angle	10% 38° / 60° / 90° / 135°
True White	CRI 70 500 lm
Warm White	CRI 80 380 lm

※All Chipset Luminous Flux Data are indicated in max values.

Optical Characteristics

Dominant Wavelength (nm) or Colour Temperature (K)

CREE LED Chips

Correlated Colour Temperature	Min.	Typ.	Max.
True White	4500K	6500K	10000K
Natural White	3750K	4000K	4250K
Warm White	2650K	2900K	3100K

BRIDGELUX LED chips

Correlated Colour Temperature	Min.	Typ.	Max.
True White	4750K	5600K	7000K
Warm White	2850K	3000K	3700K

Illuminance at Distance

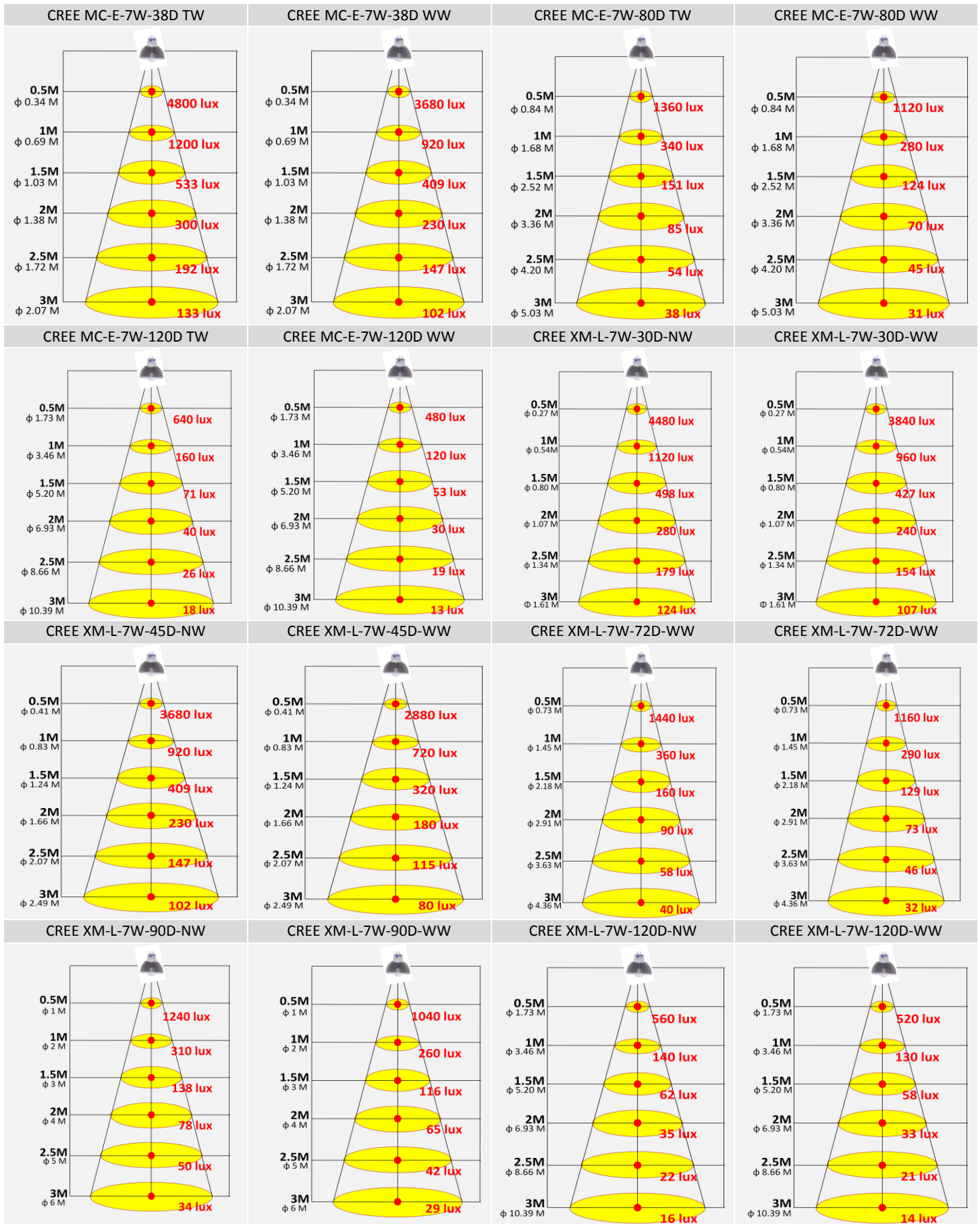

Illuminance at Distance

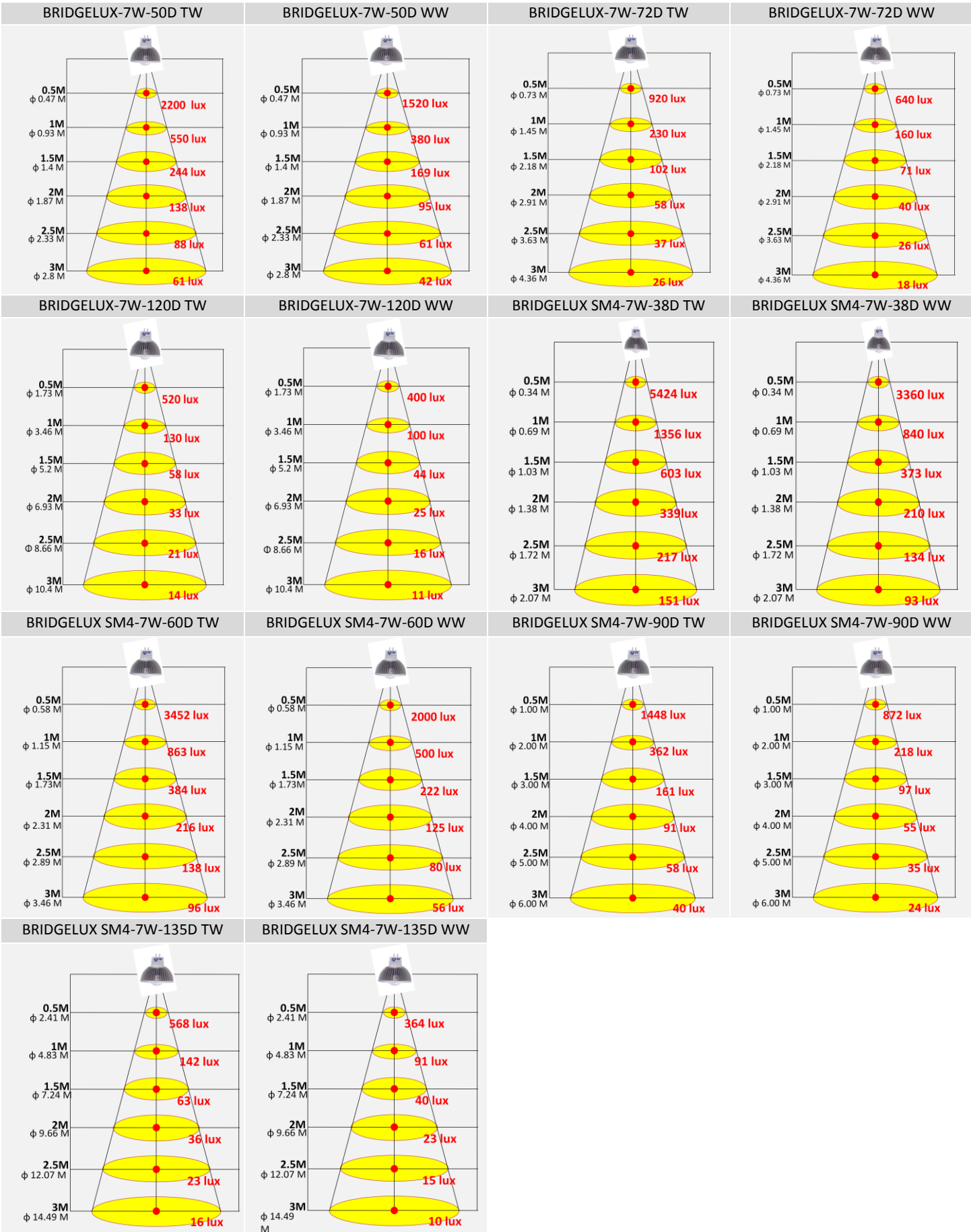

Mechanical Dimensions

Design GX5.3 / GU 5.3



Design E26/24 (US)



Design E26 / 27 (EURO)



Design GU10/GZ10



Design E11



Design E14 (US)



Design E14 (EURO)



Design E17



Design B22D

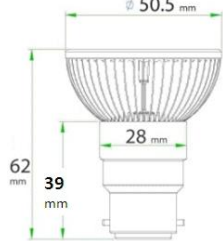

Design E12 (US)

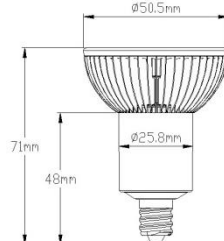

Design E12 (EURO)

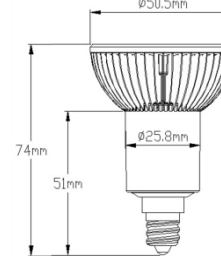

Design EZ10



Design BA15D

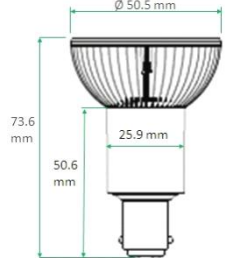

Design BA15S



M01 Fixture



M02 Fixture



ALT 8V Transformer

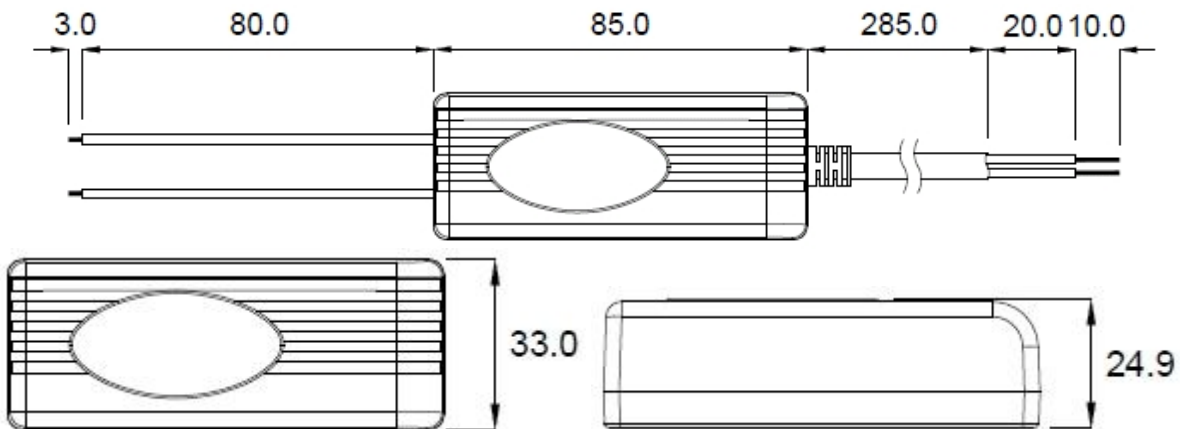

Unit : mm

Transformer Installation Instruction



Compatible Dimmers List

Compatible Dimmers List		
100V~120V AC Types		
Brand	Type	Max. Watts
ELECTRON	CONTROL	500W
LUTRON	TGCL-153PH-LA	150W
LUTRON	TG-600P	600W
LUTRON	TG-603PR-WH	600W
LUTRON	CTEL-303P	600W
LUTRON	CTCL-153PDH-WH	600W
LUTRON	DVLV-600P	600W
LUTRON	MAELV-600	600W
LUTRON	DV-603PR-WH	600W
LUTRON	S-600P-WH	600W
LUTRON	S-600H-WH	600W
LEVITON	IPL06	600W
LEVITON	IPI06	600W
LEVITON	R60-6684-1IW	600W

Compatible Dimmers List		
220V~240V AC Types		
Brand	Type	Max. Watts
CLIPSAL	TRAILING EDGE 32E450TM	450W
CLIPSAL	UNIVERSAL EDGE 31E2RUDM	350W
HPM	TRAILING EDGE - Cat 400T	400W
Hagerblu	LEADING EDG WBMD401TO	400W

Copyright © Aeon Lighting Technology Inc. All rights reserved.

ALT and ALTED are either registered trademarks of Aeon Lighting Technology Inc. in Taiwan and/or other countries. All other brand or products names are trademarks or registered trademarks of their respective owners. Due to continuous improvement and innovations, specifications may change without notice.

Aeon Lighting Technology Inc.
Rm. 8, 16F., No.2, Jian 8th Rd., Zhonghe Dist.,
New Taipei City 235, Taiwan (R.O.C.)
Tel +886-2-8226-1289
Fax +886-2-8226-9066
www.aeonlighting.com

