

V6 MR16 Dimmable



# ALTLED® Asteria Series

Specification Sheet

**ALT Transformer ONLY**

## Product Introduction

ASTERIA is a minor planet that orbits the Sun, and also considered in the Greek Mythology as the Amazon that defeat the all mighty Heracles. ALT's ASTERIA can be presented as a strong, smart and efficient light bulb. ALT's Asteria MR16 series guarantees the outstanding efficiency and quality of High Power Products. All these make our MR16 products ideal for general business and decorative lighting purpose, including shop Lighting, Hotel lighting, and Commercial Applications. You can simply install it within the showcase of the boutique, and add up bonus for the display. Also, Asteria MR16 series can easily and smartly help you lessen energy consumption up to 90%, it will enhance your business profitability and help the environment to flourish. Asteria MR16 series certainly be the product to create a more beautiful and efficient world.

## Certificates



## Features

- ✓ Smooth dimming function fades from 100% to 0% light output without flicker.
- ✓ Elegant, rich and long-lasting lighting output ideal for Interior design.
- ✓ High density aluminum increase heat dissipation.
- ✓ Up to 90% energy saving compared to standard halogen lamp.

## Application

- ✓ Shop Lighting
- ✓ Commercial Lighting
- ✓ Boutique Lighting
- ✓ Illumination Lighting
- ✓ Hotel Lighting



## Specifications

Item	Specification	Details		
Output	Beam Angle	60°, 72°, 90°, 135°		
	Colour Range	TW / NW / WW		
	Lumen Maintenance	30,000+ hours		
Electrical	Input Voltage	110V AC or 220V AC		
	Power Consumption	7 Watts		
Physical	Bases	<ul style="list-style-type: none"> <li>· GX 5.3 / GU 5.3</li> <li>· E26 / 24 (US)</li> <li>· E26 / 27 (EURO)</li> <li>· GU10 / GZ10</li> <li>· EZ10</li> <li>· E11</li> <li>· E12</li> <li>· E14</li> <li>· E17</li> <li>· B22D</li> <li>· BA15D</li> <li>· BA15S</li> </ul>		
		Weight	0.88 ~ 1.69 oz. (25 ~ 48 g)	
		Lens	Optics PMMA	
		Operating Temperature	-4° F to 104° F (-20°C to 40°C)	
		Humidity	0 – 95%, non-condensing	
		Certification and Safety	Certifications	CE, FCC, C-Tick, LVD, RoHS, Laser Testing, ETL, REACH
			Environment	Not for use in totally enclosed fixtures Suitable for damp location
			Warranty	3 years
		<b>Two Million Worldwide Product Liability Insurance.</b>		

## Chipset Luminous Flux

Chipsets	CREE MT-G	
Power Consumption	7W	
Beam Angle	10%	60° / 72° / 90° / 135°
True White	CRI 75	750 lm
Natural White	CRI 80	620 lm
Warm White	CRI 80	550 lm

※All Chipset Luminous Flux Data are indicated in max values.

## Optical Characteristics

Dominant Wavelength (nm) or Colour Temperature (K)

Correlated Colour Temperature	Typ.
True White	5000K
Natural White	4000K
Warm White	3000K
	2700K

## Illuminance at Distance

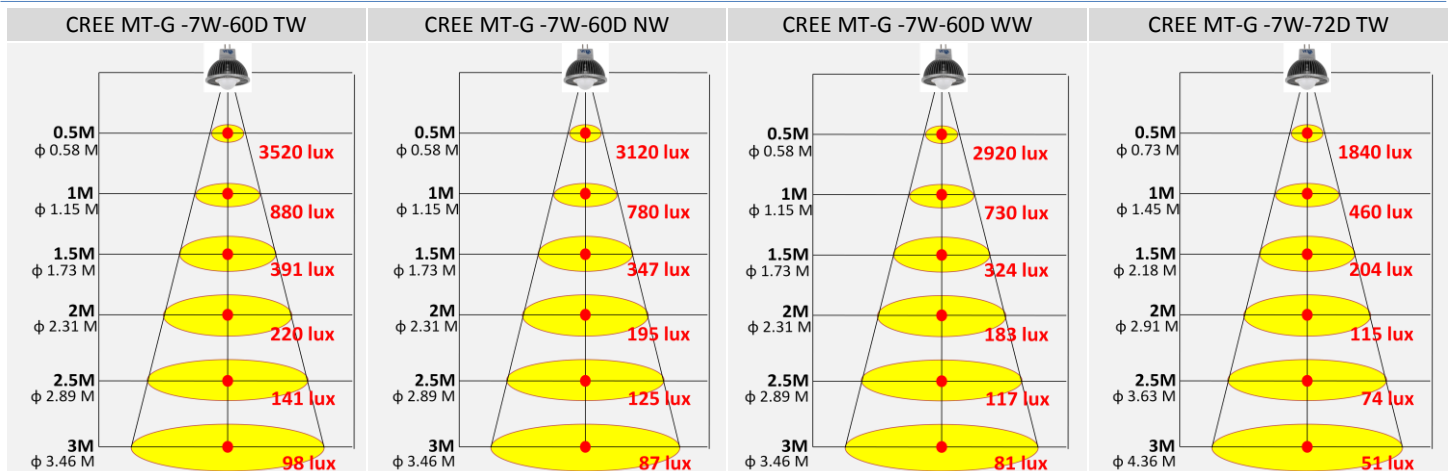

# Illuminance at Distance

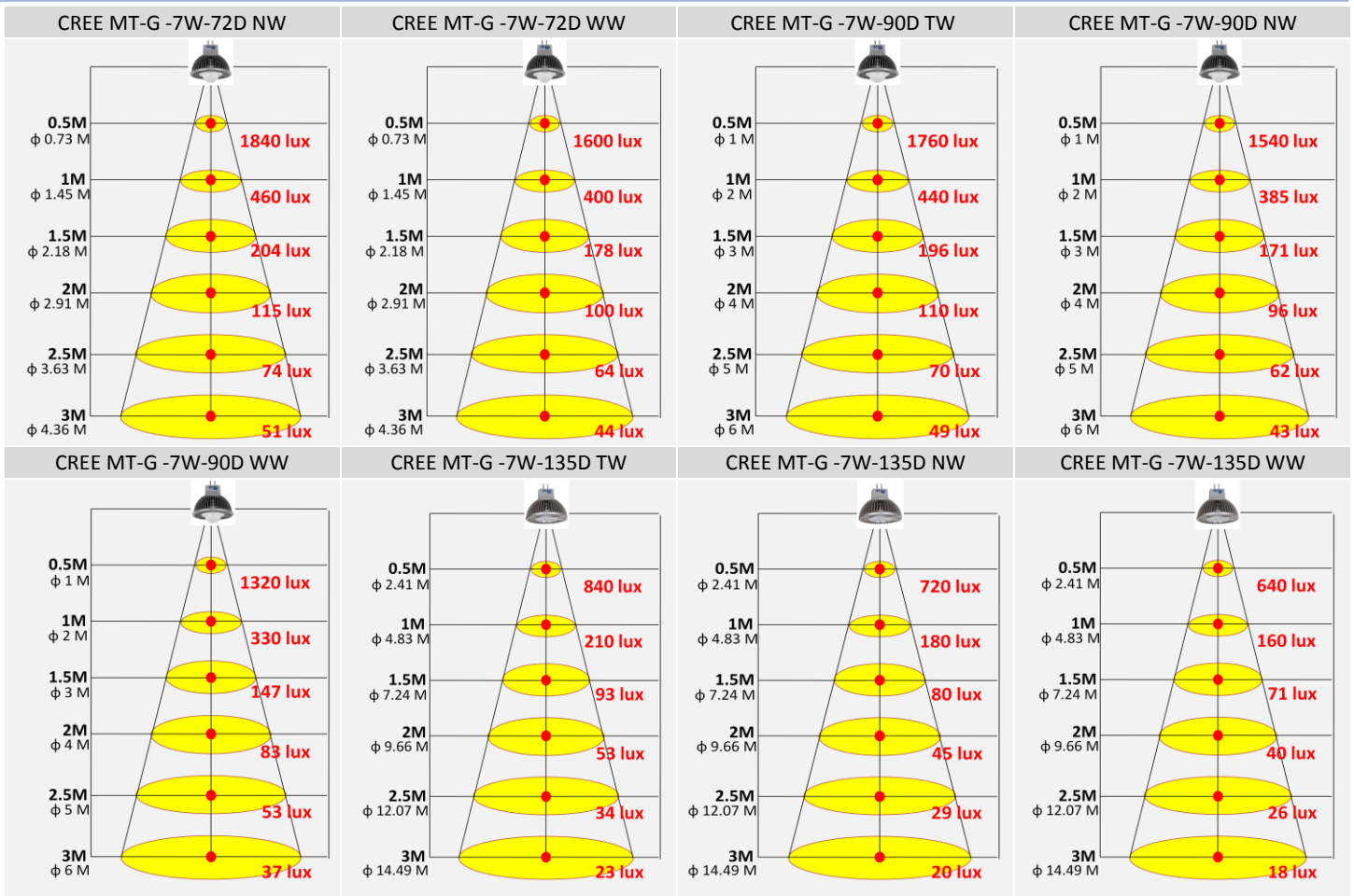

# Mechanical Dimensions

Design GX5.3 / GU 5.3



Design E26/24 (US)



Design E26 / 27 (EURO)



Design GU10/GZ10



Design E11



Design E14 (US)



Design E14 (EURO)



Design E17

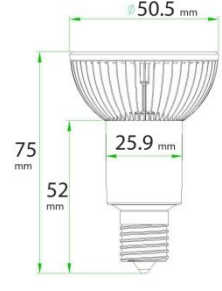

Design B22D



Design E12 (US)

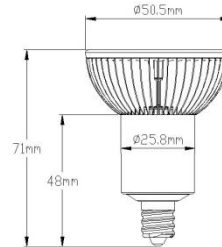

Design E12 (EURO)

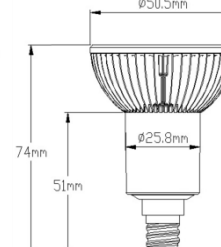

Design EZ10



Design BA15D

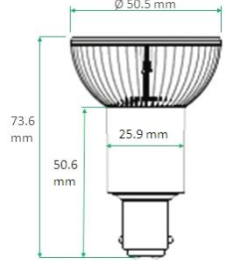

Design BA15S



M01 Fixture

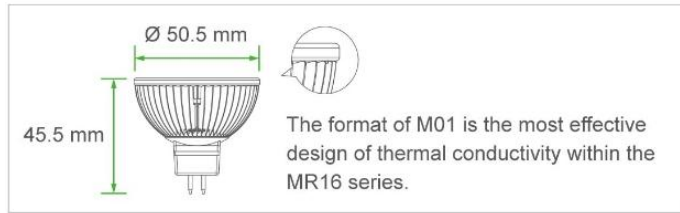

M02 Fixture



ALT 8V Transformer

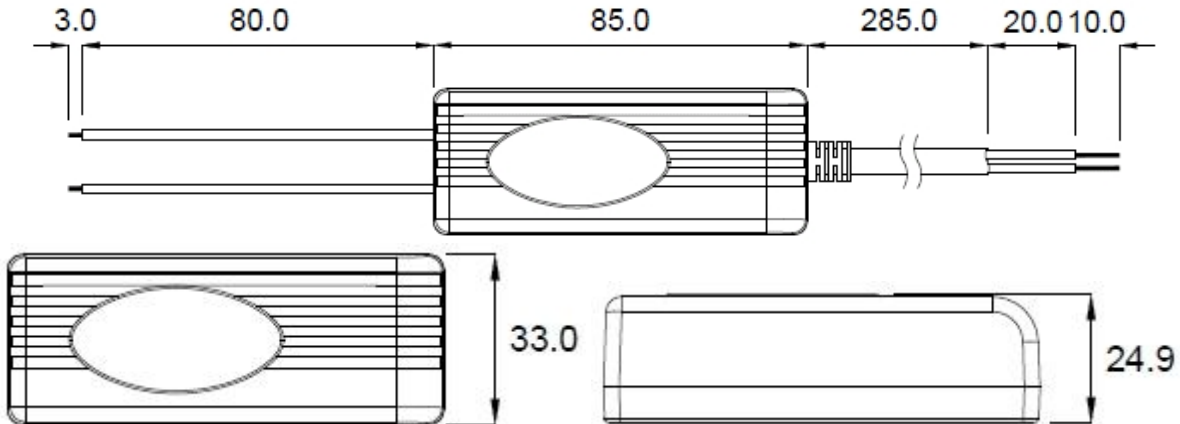

Unit : mm

## Transformer Installation Instruction

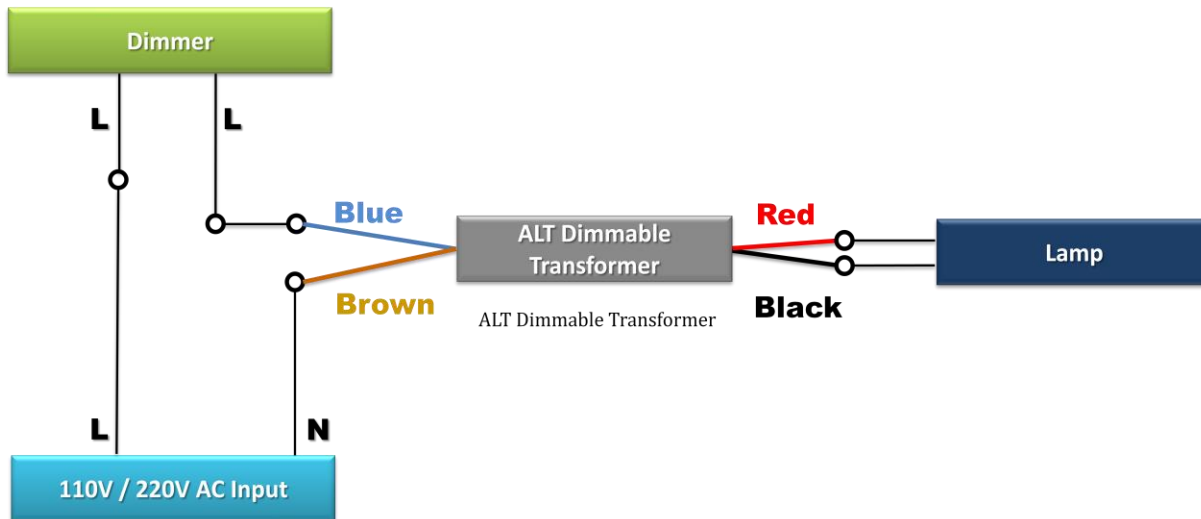

## Compatible Dimmers List

Compatible Dimmers List		
100V~120V AC Types		
Brand	Type	Max. Watts
ELECTRON	CONTROL	500W
LUTRON	TGCL-153PH-LA	150W
LUTRON	TG-600P	600W
LUTRON	TG-603PR-WH	600W
LUTRON	CTEL-303P	600W
LUTRON	CTCL-153PDH-WH	600W
LUTRON	DVLV-600P	600W
LUTRON	MAELV-600	600W
LUTRON	DV-603PR-WH	600W
LUTRON	S-600P-WH	600W
LUTRON	S-600H-WH	600W
LEVITON	IPL06	600W
LEVITON	IPI06	600W
LEVITON	R60-6684-1IW	600W

Compatible Dimmers List		
220V~240V AC Types		
Brand	Type	Max. Watts
CLIPSAL	TRAILING EDGE 32E450TM	450W
CLIPSAL	UNIVERSAL EDGE 31E2RUDM	350W
HPM	TRAILING EDGE - Cat 400T	400W
Hagerblu	LEADING EDG WBMD401TO	400W

Aeon Lighting Technology Inc.  
 16F-8., No.2, Jian 8th Rd., Zhonghe Dist.,  
 New Taipei City 235, Taiwan (R.O.C.)  
 Tel +886-2-8226-1289  
 Fax +886-2-8226-9066  
[www.aeonlighting.com](http://www.aeonlighting.com)

